

Area		EUROPE	GENERAL AREA
Model Name		KD-65XG8505	KD-65X8500G
SV No.		SV-36050	SV-36058
DIMENSION	TV only (WxHxD)	Approx. 145.0x83.6x5.2(1.41) cm	Approx. 1450x836x52(14.1) mm
	TV with Stand (WxHxD)	Approx. 145.0x89.9x31.6 cm	Approx. 1450x899x316 mm
	Media Receiver (WxHxD)	-	-
	Monitor only (WxHxD)	-	-
	Monitor with Stand (WxHxD)	-	-
	Media Receiver with Stand (WxHxD)	-	-
WEIGHT	TV Only	Approx. 25.3 Kg	Approx. 25.3 Kg
	TV With Stand	Approx. 26.3 Kg	Approx. 26.3 Kg
	Media Receiver	-	-
	Monitor Only	-	-
Remarks	Stand Width	Approx. 105.9 cm	Approx. 1059 mm
	VESA Hole Pitch	30.0x30.0 cm	300x300 mm
	TV Only	Approx. 25.3 Kg	Approx. 25.3 Kg
	Media Receiver with Stand	-	-

WITH STAND

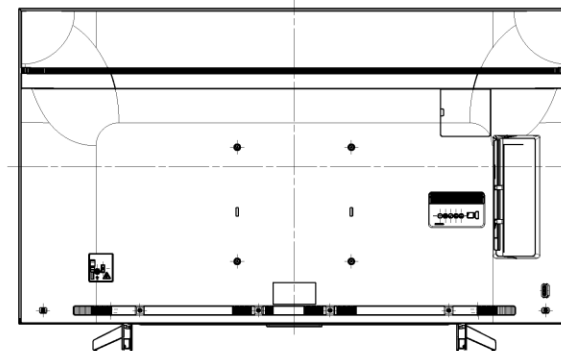
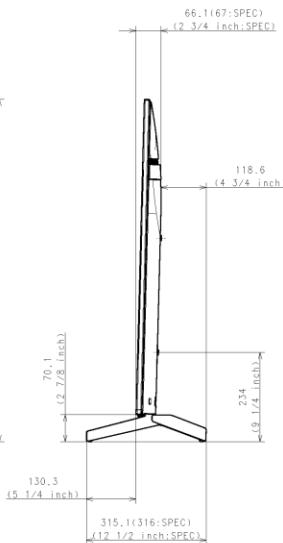
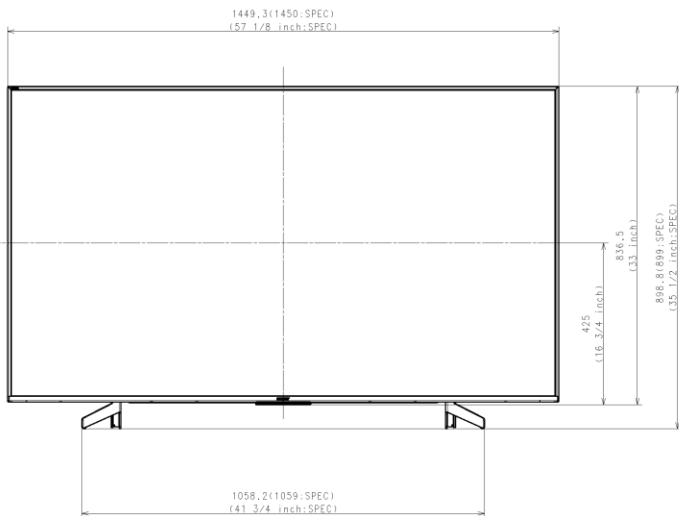

Purchase recycled resins and wire rods only from the business partners that Sony approves as Green Partners.
 RECYCLED RESINS AND WIRE RODS ONLY FROM GREEN PARTNERS

DATE	2018.10.19	REVISED	
DESCRIPTION	65(X8500G) EXTERIOR VIEW		
DESIGNED BY	DESIGNED	APPROVED BY	DATE
SVPM Design 3			
SCALE	1:6	DRAWING NO. 65(X8500G) EXTERIOR VIEW	
DATE	2018.10.19	DATE	2018.10.19
REVISED		REVISED	

WITHOUT STAND

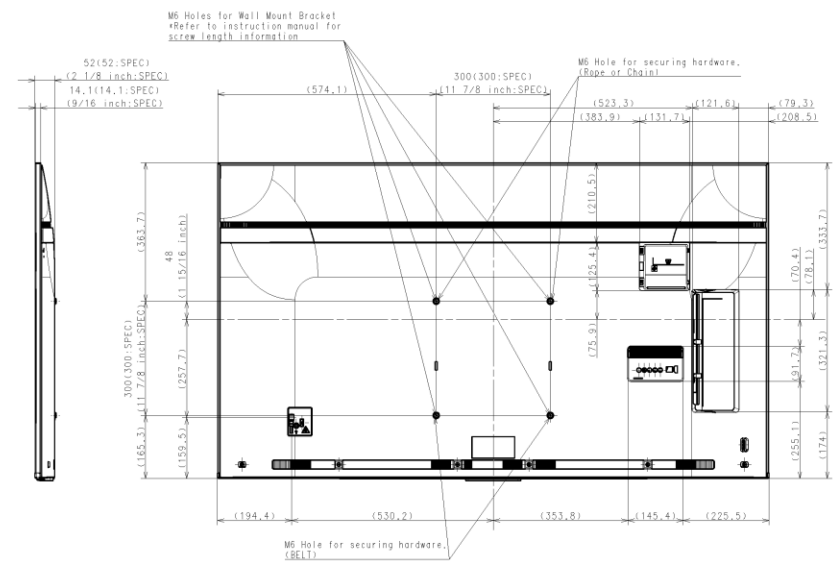
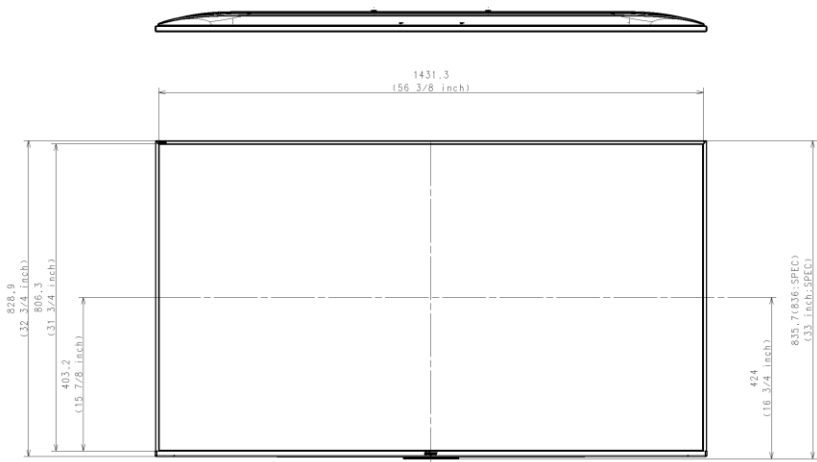

SU-WL450

STANDARD MOUNT

SLIM MOUNT

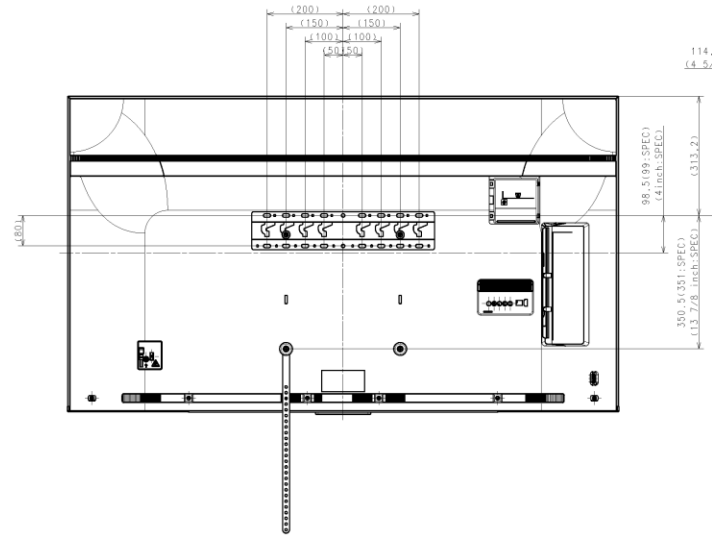

114.3 (115 SPEC)
(4 5/8 inch SPEC)

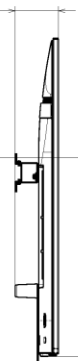

72.5 (73 SPEC)
(2 7/8 inch SPEC)

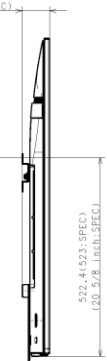

MODEL NO.	ESLW5000L EXTERIOR VIEW	REV. NO.	1.0
DATE	2016.03.16	DESIGNER	Y. KAWANO
APPROVER	T. YAMAGUCHI	DATE	2016.03.16
REVISION	1.0	REVISION	1.0

SU-WL820

SU-WL820 with LATERAL SHAFT BRACKET

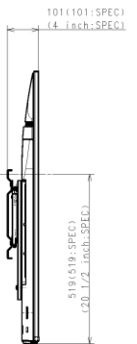
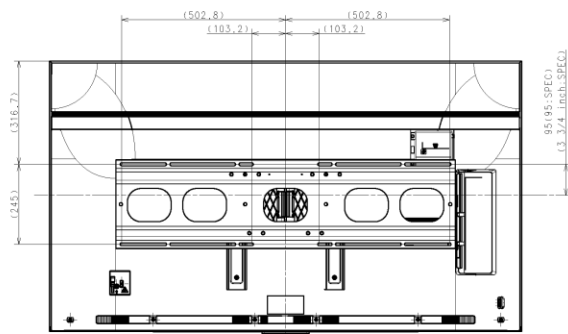
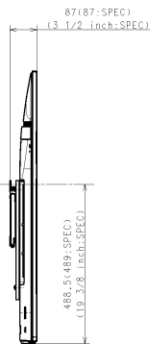
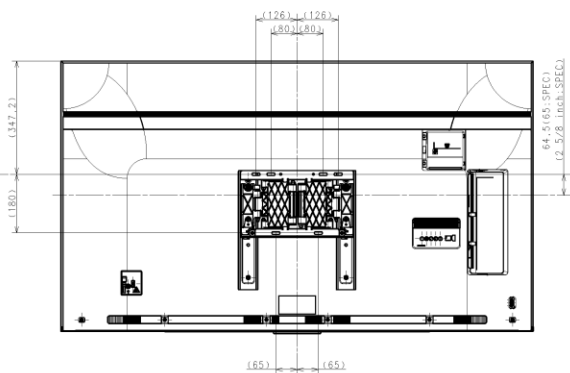

Part No.	Doc No.	Date
65(X8500G) EXTERIOR VIEW	Sony Corporation	1-77
65(X8500G) EXTERIOR VIEW		3/ 3